

AgieCharmilles

# FORM P

350/600/900



# Becoming better every day – since 1802

## GF Machining Solutions

When all you need is everything, it's good to know that there is one company that you can count on to deliver complete solutions and services. From unmatched Electrical Discharge Machining (EDM), Laser texturing, Laser micromachining, Additive Manufacturing and first-class Milling and Spindles to Tooling and Automation, all of our solutions are backed by unrivaled customer service and expert GF Machining Solutions training. Our AgieCharmilles, Microlution, Mikron Mill, Liechti, Step-Tec and System 3R technologies help you raise your game—and our digital business solutions for intelligent manufacturing, offering embedded expertise and optimized production processes across all industries, increase your competitive edge.



+ We are AgieCharmilles.  
We are GF Machining Solutions.

# Contents

4	Highlights
6	Optimize your production
8	Drive speed and quality
10	Shorten your delivery time
12	Availability is key for your business
14	Reduce energy consumption
16	Customer Services
17	EDM graphite
18	Technical specifications
22	About GF Machining Solutions

## **Perfect results at your fingertips**

The ergonomics of GF Machining Solutions' new AC FORM human-machine interface (HMI) put customers in the driver's seat by making die-sinking EDM an intuitive, easy-to-learn and easy-to-use process. That means greater autonomy over your processes, higher efficiency, improved process reliability and accelerated performance. The standardized working environment created by the AC FORM HMI makes it easy to achieve perfect machining results.



Highlights

**Boost your  
running time  
with efficiency**



## + Optimize your production

The AgieCharmilles FORM P series includes a whole family of choices: Achieve your production objectives and meet your customers' expectations, with three different sizes of machines delivering the control of accuracy you need, thanks to rigid mechanics and high-resolution glass scales. Moreover, the AgieCharmilles FORM P series' available Accura C-axis and its high-torque capability help you execute complex cavities.

- + Compact and rigid mechanical concept
- + Accura C-axis, the best high-performance axis on the market
- + Linear glass scales: lifetime accuracy
- + Thermostabilization

## + Drive speed and quality

The AgieCharmilles FORM P series leads to high running time without manual intervention thanks to multiple available Automation solutions. Profit from a pallet/electrode changer (linear, rotary, robot) as well as smart features like Part Express and Job List management.

- + The ultimate in ergonomics
- + Intelligent Speed Power Generator based on legendary EDM expertise
- + Fastest graphite technology
- + Fast polishing of deep 3D shapes

## + Shorten your delivery time

GF Machining Solutions' die-sinking EDM know-how is fully embedded in the FORM P series through its EDM process management. Our Intelligent Speed Power Generator (ISPG), in association with innovative feature iGap, maximizes the material removal ratio by generating the best EDM spark settings in keeping a perfect surface finish accuracy.

- + High autonomy and reduction in dead time
- + Boost your competitiveness
- + Increased autonomy without manual intervention
- + Aim: 7,000 hours of EDM machining per year

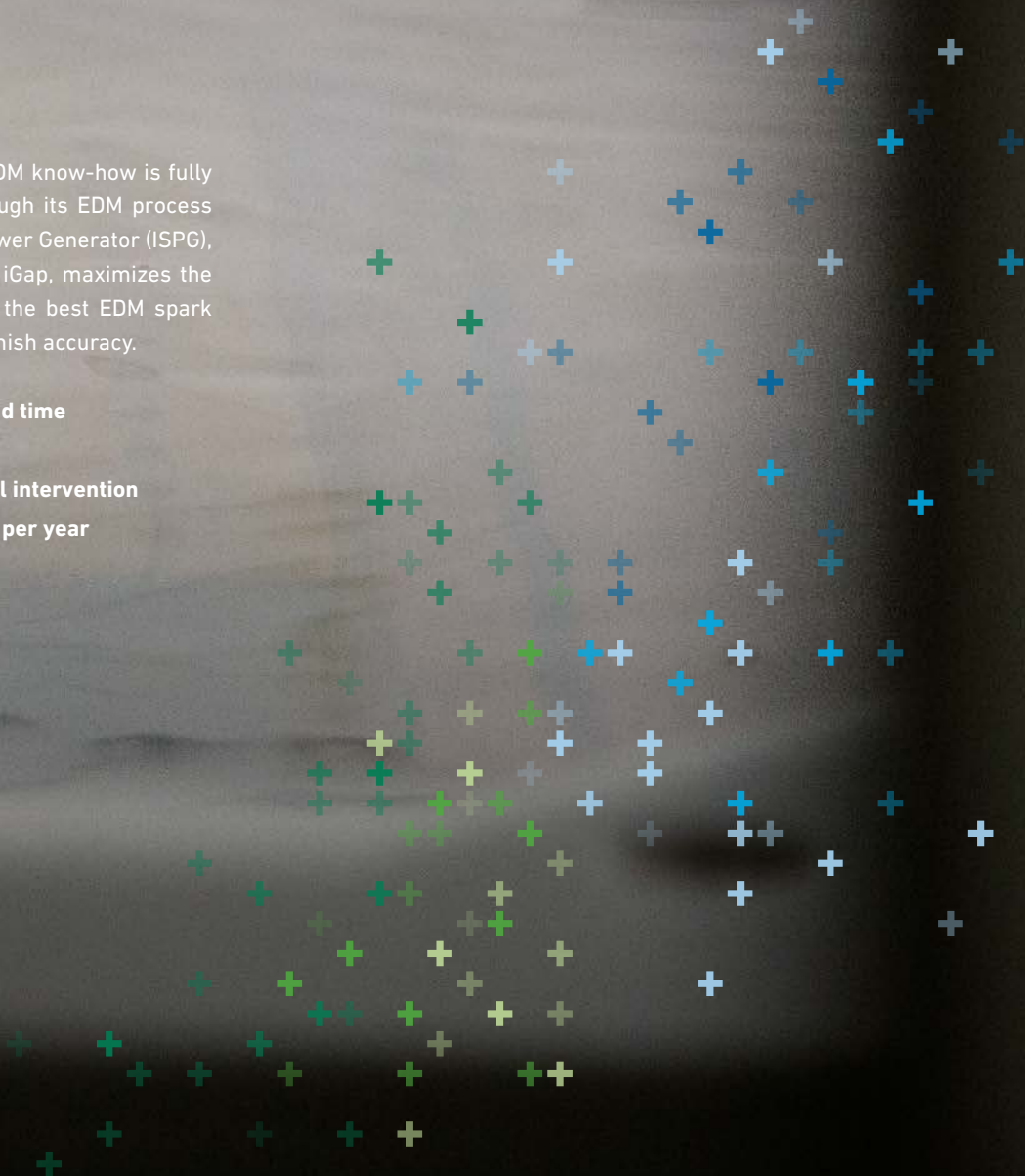

Optimize your production

# Meet customers' expectations

## Compact and rigid mechanical concept

A short C-frame construction and the oversized casting guarantee mechanical stability and precision throughout the life of the machine. In addition, the robustness of the machine absorbs all the machining forces to maintain a precise gap between the part and the electrode.

## Linear glass scales: lifetime accuracy

To obtain reliable positioning accuracy, only linear glass scales are effective. They eliminate all the classic errors, such as backlash, expansion and wear effects. The axis servo control system developed by GF Machining Solutions is a closed loop measurement solution designed to provide infallible accuracy, whatever the travel.





### **Accura C axis, the best high-performance axis on the market**

It is not unusual to be confronted by machining where the electrodes are incorrectly located, even by such a distance that maintaining their position or stability during machining becomes problematic. Pulsation-induced movements in a liquid (dielectric) medium generate lateral forces (flexural or rotational) on the electrode, which must be resisted by the C axis. Thanks to its very robust design, the Accura C axis allows very high moments of inertia to be absorbed, up to 5000 kgcm<sup>2</sup>.

### **Thermostabilization**

Only available on the AgieCharmilles FORM P 600 as a variant, the thermostabilization provides perfect and accurate machining every time and whatever the temperature conditions.

### **Higher accessibility**

The AgieCharmilles FORM P machines, available in three sizes, are equipped with an automatic drop tank. This allows you optimum access to the work zone.



Drive speed and quality

# Flexibility and power guarantee reliable results

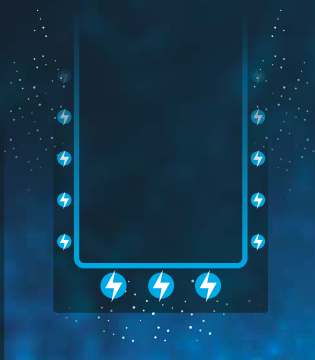

**Fastest graphite technology**  
Our dynamic iGAP feature maximizes the material removal rate while maintaining the accuracy of details and consistent surface finish.

## The ultimate in ergonomics

Optimal machining strategies are at your fingertip with our AC FORM HMI's clear choices for each application. The operator introduces—on a single screen—machining parameters such as surface state, depth, machining cycle, and type of application to extract the best generator performance.

Strict minimum of electrode use at higher speed thanks to the wear partitioning

Outstanding productivity on irregular surfaces

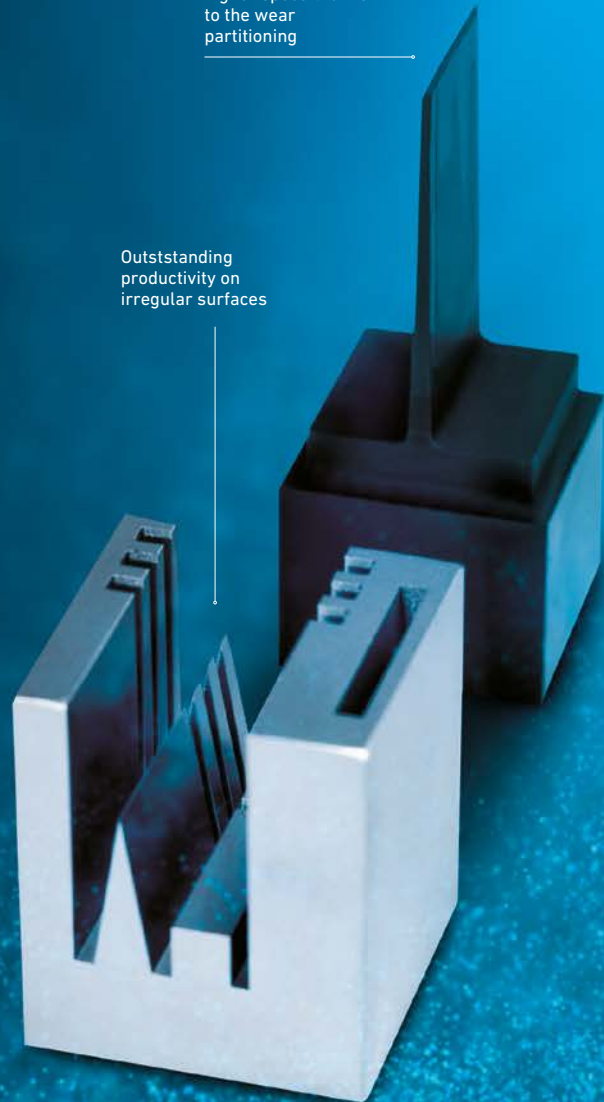

Machining time < 4h  
AC-K900 graphite electrode x1

## Intelligent Speed Power Generator based on our EDM legacy

With our high-end generator, the EDM process is continuously optimized with every pulse, reducing electrode wear on even the finest finishes. Process control takes a fraction of second and produces an extremely homogeneous surface finish.



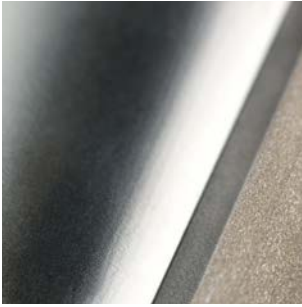

#### Fast polishing of deep 3D shapes

Reach the finest surface quality inside a deep, full material cavities, significantly reducing polishing time. With our mix-materials function start fast with graphite and finish with copper for high quality.



Machining time including polishing :  
10 h 50 min  
AC-K900 graphite electrode x2  
Copper electrode x1  
Surface finish : Ra 0.12 µm

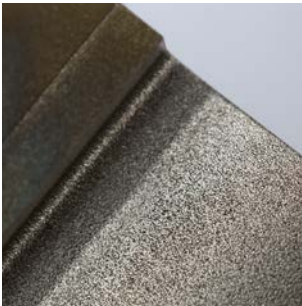

#### 3DS technology perfects your surfaces

The 3DS technology minimizes residue accumulation on molds and reduces friction and ejection forces in the plastic injection process. That means higher productivity and flexibility, greater end- product quality, more repeatability in your mold making process, and homogeneity of granularity.



Machining time including polishing :  
6 h 30 min  
AC-K800 graphite electrode x2  
Copper electrode x1  
Surface finish : Ra 1.5 µm

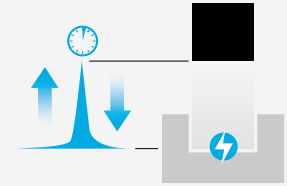

#### High Velocity Pulsation (HVP)

- Efficient cavity cleaning by rapid retraction
- Good flushing conditions
- Optimum erosion results

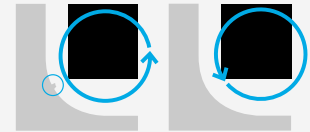

#### Predict Learning System (PLS)

- Orbital movements are recorded and analyzed.
- Deviation is optimized one step after the other.
- Cavities are made quickly and accurately.

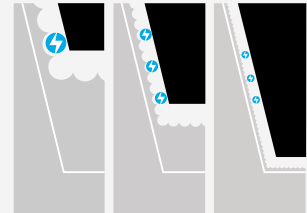

#### Mastery of spark generator

- Higher removal rate thanks to the ISPG
- Optimize each spark generated by the generator.
- Reduce electrode wear

#### Ensure positioning precision

To ensure positioning precision, an optical transmission probe can be managed by the AgieCharmilles FORM P 350/600/900. Measurement allows dimensional inspection of machined cavities as well as the taking of references of the part without having to remove it, thus saving a considerable amount of time. Furthermore, a measurement report is automatically generated by AC FORM HMI to accommodate rigorous checking and monitoring.

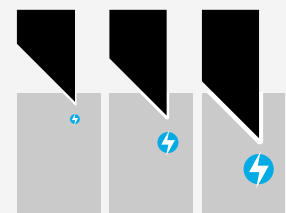

#### Controlled process

- Adaptive Current Control (ACC)
- Adaptive Current Optimization (ACO)
- Increase productivity with perfect algorithms.



Shorten your delivery time

# Unattended machining

## High autonomy and reduction in dead time

The AgieCharmilles FORM P 350/600/900 can be equipped with integrated tool changers, allowing them to work for long periods without human intervention. These linear changers allow satisfactory autonomy for work requiring a smaller number of tools. For the FORM P 900, this integrated tool changer can be installed on the left, on the right or on both sides at the same time keeping machine dimensions to a strict minimum.

FORM P 350: four positions

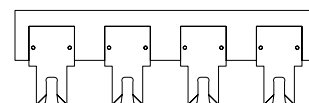

FORM P 600: six positions

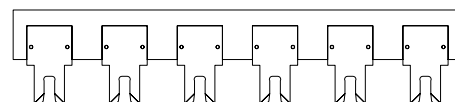

FORM P 900: ten positions x2

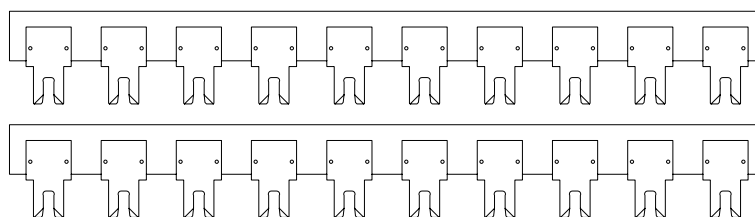

### Increased autonomy without manual intervention

Manufacturing a mold often requires a large number of electrodes whose spark erosion time can vary noticeably from one cavity to another. The AgieCharmilles FORM P 350/600 machines have a new rotary changer which offers large storage capacity for up to 160 electrodes. A double gripper clamp reduces unnecessary movements, notably speeding up the loading process.

### Aim: 7,000 hours of EDM machining per year

Autonomous cell management maximizes machining time from 2,500 hours on average, to close to 7,000 hours per year. Thanks to the AC FORM HMI, tool changer cycles are optimized and operators can import CAD/CAM data during machining allowing continuous production.

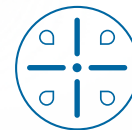

Tooling

### Boost your competitiveness

Automation keeps production going whatever the time of day or day of the week. Your results are shorter lead times, higher productivity and quicker payback of capital invested in machines. With automated operations, production can continue running round the clock, seven days a week. The possibilities are endless.

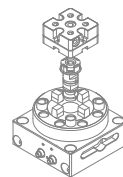

Macro

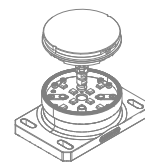

MacroMagnum

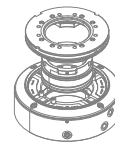

Matrix

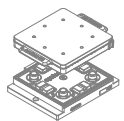

Dynafix

Availability is key for your business

# Connecting you to the future

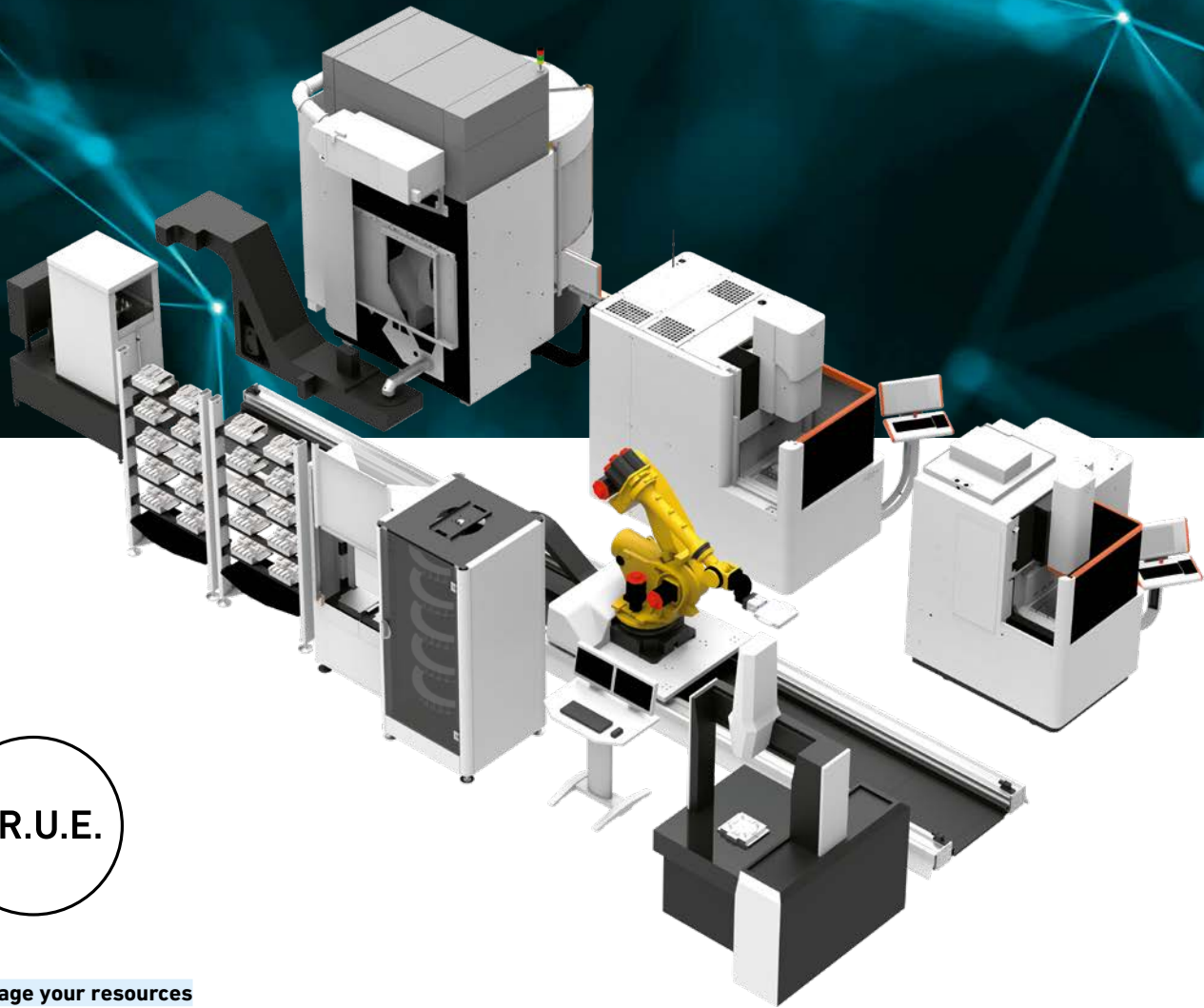

T.R.U.E.

## Manage your resources

T.R.U.E. (True Response to User Expectation) PRECISION is an innovative manufacturing solution for optimizing the die-sinking electrical discharge machining (EDM) process based on the true geometry of the electrode. This software is used in Automation cells between AgieCharmilles die sinking EDM and Mikron Mill machines through an uninterrupted workflow in order to compare whether the electrodes produced by the Milling machine match with the CAD/CAM data. The aim is to ensure the highest accuracy and consistency on the electrodes produced.

## Aligned with Industry 4.0

Aligned with Industry 4.0's vision of the smart factory of the future, T.R.U.E. PRECISION intelligently addresses real-world manufacturing challenges including the growing complexity of parts and molds. Meeting the needs of a mass production intensive market, our Automation cell connecting AgieCharmilles die-sinking EDM machines and Mikron Mill machines for the production of electrodes, manual operator intervention is significantly reduced. T.R.U.E. PRECISION lays the foundation for achieving higher accuracy and tighter tolerances, greater productivity, faster time to market, full predictability, and the cost reductions needed for die-sinking machining.





### Industry 4.0

GF Machining Solutions' die-sinking EDM is completely aligned with Industry 4.0 and your need to optimize production processes with intelligent information use. We understand that machines are part of a larger puzzle consisting of creation, simulation and post-processing stages. That's why we collaborate with multiple partners to connect all stages and make them complementary.



## rConnect

### Secure highest availability with rConnect

rConnect brings smart manufacturing to your workshop. Our innovative applications make machine intelligence always available to ensure that your workshop operates to its full potential at all times.

### Your benefits with rConnect

- Detailed information about your machine with your cockpit per machine
- More uptime for your machinery
- Direct and interactive access to our service specialists
- Faster identification of potential problems
- Secure connection based on the latest technology—certified by TÜVIT
- A significant step toward smart services to increase your efficiency



### rConnect Live Remote Assistance

With rConnect Live Remote Assistance, rely on our expert engineers to rapidly respond to your service requests. Our solution connects you to our experts for remote assistance in real time.



### rConnect Messenger

rConnect Messenger delivers machine data to your mobile device. You gain insight into the efficiency of your workshop by continuously monitoring your machines.

Reduce energy consumption

# Manage your resources

## Econowatt Smart module: Take action to save energy

For several years, the cost of energy has been spiraling out of control. For this reason, controlling production costs and saving energy have become priorities for all workshops. The Econowatt Smart module makes GF Machining Solutions the industry leader in energy saving and environmental protection.

## Improve competitiveness

- An automatic wake up can be programmed in a weekly calendar
- Before the scheduled time for restarting work, the machine automatically restarts to enable thermostabilization of the dielectric.
- Each morning the equipment is found in perfect working order, ready to perform precision work.





With the Econowatt Smart module you can save, per machine, enough energy to run two houses for a year.

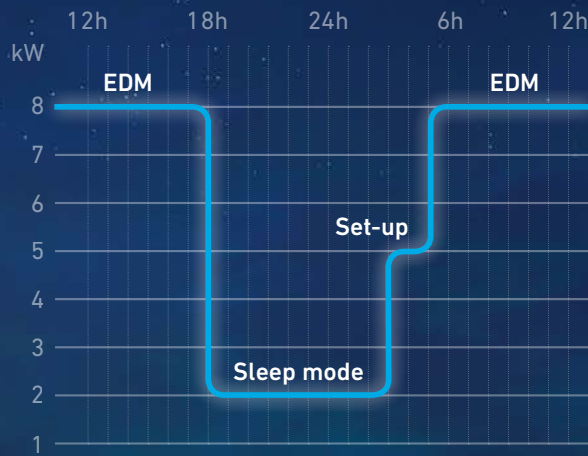



Customer Services

# Accelerate your production to new levels of success

Experience the highest performance of your equipment with GF Machining Solutions Customer Services providing you with unbeatable life cycle support.

## **Keep pace in a changing environment**

As your business evolves, so does its needs, and you can count on GF Machining Solutions for the individually tailored solutions to enhance your operational excellence. We help you keep pace with the continuously changing business and market environments and outperform your competitors.



### **Operations Support: solutions to boost your applications**

Your single source provider of a vast selection of certified consumables including electrodes and filters to achieve optimum level of performance.



### **Machine support: securing your sustainable machining success**

Preventive maintenance as well as advanced preventive services such as circularity tests with ball bar or laser calibration will optimize your uptime.



### **Business support: realize the full potential of your equipment**

Advanced support and consulting—including training, upgrades and dedicated Automation solutions—to improve your performance, productivity and competitive edge.



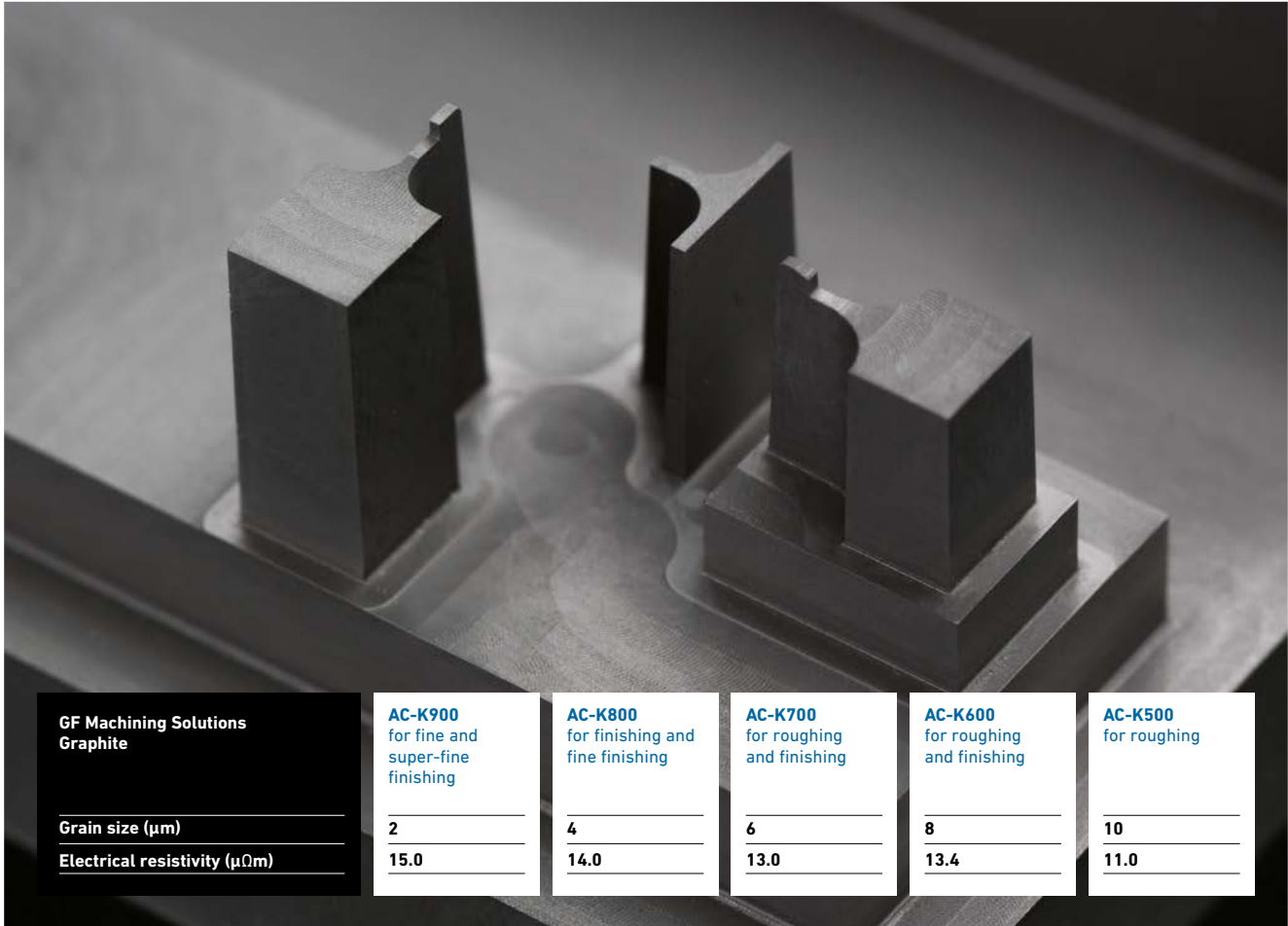

## EDM graphite

# Increase your productivity, optimize your costs and time

GF Machining Solutions offers various grades of graphite with a wide range of performance characteristics. Each grade can be dedicated to a specific range of applications.

### Easy and quick machining, no deburring

Excellent machinability result in high cutting speed rate and time savings in electrode production. In contrast to copper electrodes, graphite electrodes require no additional deburring operation.

### Higher removal rate and high resistance to wear compared to copper

Optimal erosion time and minimal electrode wear results in both cost and time savings.

### High thermal stability and high resistant to thermal shock

Electrode dimensions remain stable during the erosion process and high current densities are maintained. Graphite's light weight makes it easier to manage and handle large electrodes and optimize electrode costs.

### Saw-cut service

- We can cut your graphite block to the size you need and in the grade that best fits your application.
- Contact your local partner to discuss your desired dimensions and graphite grade.

## Technical specifications



**FORM P 350**

**FORM P 600**

**FORM P 900**

		FORM P 350	FORM P 600	FORM P 900
<b>Machine</b>				
Architecture		C-frame/Fixed table/Drop tank		
Dimensions (*)	mm (in)	1900 x 1690 x 2398 (74.80 x 66.53 x 94.4)	2265 x 2110 x 2780 (89.17 x 83.07 x 109.45)	2970 x 3100 x 3320 (116.93 x 122.05 x 130.71)
Total weight (without dielectric)	kg (lbs)	2800 (6173)	4500 (9920)	7000 (15432)
Floor space (**)	mm (in)	1900 x 1690 (74.80 x 66.53)	3040 x 2830 (119.68 x 111.42)	2970 x 3100 (116.93 x 122.05)
Complies with "Machines, Safety and Health" directive		89/392/CEE	89/392/CEE	89/392/CEE
Complies with "Electromagnetic Compatibility" directive		89/336/CEE	89/336/CEE	89/336/CEE
<b>X, Y, Z axes</b>				
X, Y, Z travel (*)	mm (in)	350 x 250 x 300 (13.78 x 9.84 x 11.81)	600 x 400 x 450 (23.62 x 15.75 x 17.72)	900 x 700 x 500 (35.43 x 27.56 x 19.68)
X, Y, axes speed	m/min (ft/min)	6 (19.7)	6 (19.7)	6 (19.7)
Z axis speed	m/min (ft/min)	15 (49.2)	10 (32.8)	7.5 (24.6)
Positioning resolution X, Y, Z	µm (in)	0.05 (0.000002)	0.05 (0.000002)	0.05 (0.000002)
<b>Work area</b>				
Worktank size (*)	mm (in)	800 x 520 x 350 (31.49 x 20.47 x 13.78)	1216 x 810 x 470 (47.87 x 31.89 x 18.50)	1814 x 1215 x 700 (71.42 x 47.83 x 27.56) Extendable in X
Worktable size (**)	mm (in)	500 x 400 (19.68 x 15.75)	750 x 600 (29.53 x 23.62)	1100 x 900 (43.31 x 35.43)
Distance floor to clamping level	mm (in)	1000 (39.37)	1000 (39.37)	1100 (43.31)
Min./Max. distance between table and chuck (***)	mm (in)	150/450 (5.91/17.72)	150/600 (5.91/23.62)	322/822 (12.68/32.36)
<b>Workpiece and electrode</b>				
Max. electrode weight	kg (lbs)	50 (110.23)	50 (110.23)	50 (110.23)
Max. workpiece weight	kg (lbs)	500 (1102.31)	1600 (3527.40)	3000 (6613.86)
Max. workpiece dimensions (*)	mm (in)	700 x 460 x 285 (27.56 x 18.11 x 11.22)	1040 x 730 x 410 (40.94 x 28.74 x 16.14)	1670 x 1120 x 560 (65.75 x 40.09 x 22.05)
Bath level (programmable)	mm (in)	100 - 305 (3.94 - 12.01)	100 - 400 (3.94 - 15.75)	100 - 550 (3.94 - 21.65)

\* Width x depth x height \*\* Width x depth \*\*\* With C-Axis Eco + System 3R Macro

		FORM P 350	FORM P 600	FORM P 900
<b>Dielectric unit</b>				
Capacity	l (gal)	410 (108.65)	700 (184.8)	2500 (662.5)
Number of filter elements and type		4 Paper filter	6 Paper filter	8 Paper filter
<b>Generator</b>				
Generator type		ISPG	ISPG	ISPG
Max. machining current (option)	A	80 (140)	80 (140)	80 (140)
Best surface finish	µm Ra	0.08	0.08	0.1
<b>Electrical supply standard</b>				
Standard voltage		3 x 380V/400V ± 10%. 50/60Hz (50Hz standard)		
<b>Cooling</b>				
Heat exchanger dielectricum/water for the dielectricum		Integrated	Integrated	Integrated
<b>Control Unit</b>				
Operating system		Windows		
Data input		15" LCD screen, mouse or touch screen, keyboard and remote control		
User interface		AC FORM HMI		
Expert systems		TECFORM		
Console support		Movable on cabinet or on foot		
<b>Modules</b>				
Z axis (15 m/min)		Standard	—	Option
Linear tool changer (*)		4 (Std. tooling) 5 (Combi tooling)	6 (Std. tooling) 6 (Combi tooling)	10 (Std. tooling) Left 10 (Std. tooling) Right
Rotary tool changer (*)		16-80 pos. (Std. tooling) 32-160 pos. (Combi tooling)	16-80 pos. (Std. tooling) 32-160 pos. (Combi tooling)	— —
Flushing Injections		2 Laterals, 1 through the piece, 1 through the electrode, 1 suction		
Heat exchanger air/water for the cabinet		Option	Option	Option
Multicavity flushing 6 outputs		Option	Option	Option
3D probe measuring system for Erowa or System 3R		Option	Option	Option
iQ graphite and copper module for reduction of electrodes' wear		Standard	Standard	Standard
<b>Standard C-Axis (*)</b>				
Max. electrode weight on automatic chuck	kg (lbs)	25 (55.12)	25 (55.12)	25 (55.12)
Rotation speed	rpm	0-100	0-100	0-100
Max. inertia	kgcm <sup>2</sup> (lbsin <sup>2</sup> )	2000 (683)	2000 (683)	2000 (683)
<b>Accura C-Axis (*)</b>				
Max. electrode weight on automatic chuck	kg (lbs)	25 (55.12)	25 (55.12)	25 (55.12)
Rotation speed	rpm	0-100	0-100	0-100
Max. inertia	kgcm <sup>2</sup> (lbsin <sup>2</sup> )	5000 (1700)	5000 (1700)	5000 (1700)

\* Option

**FORM P 350**

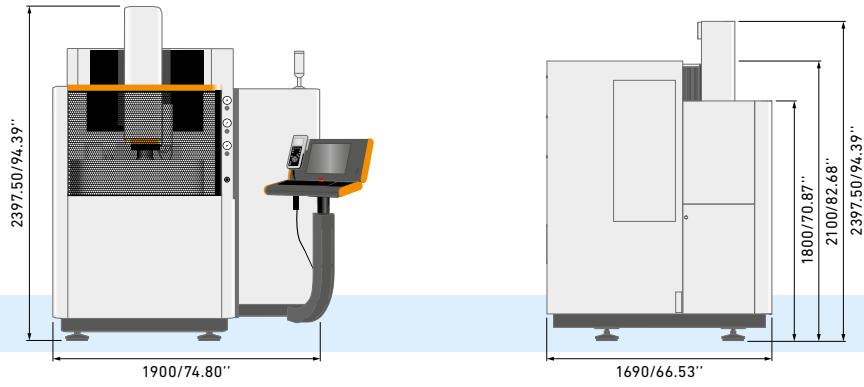

**FORM P 350 + LTC**

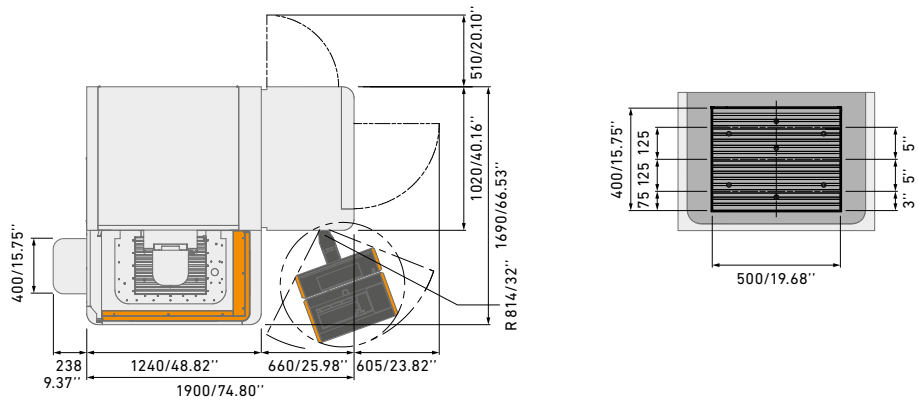

**FORM P 600**

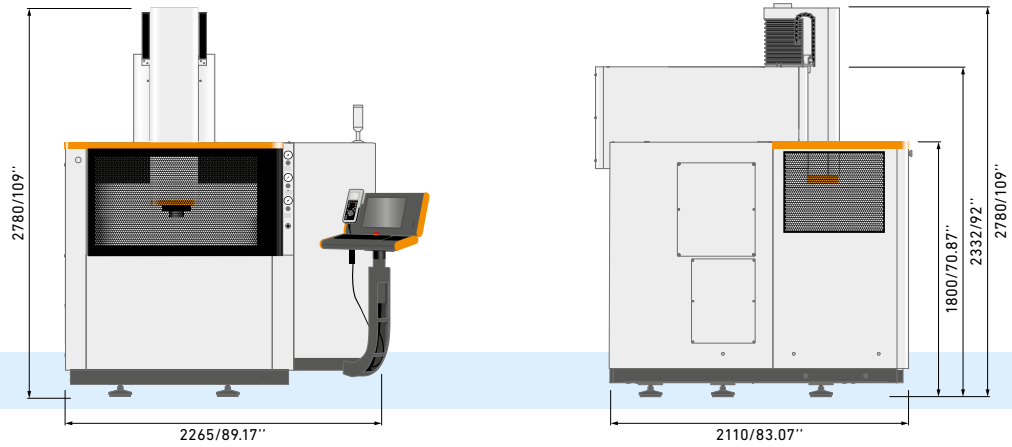

**FORM P 600 + LTC**

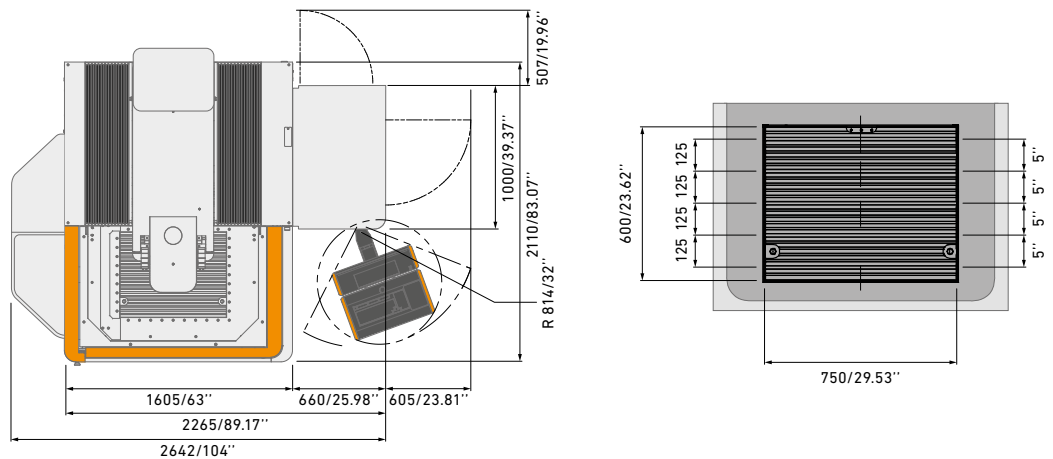



**FORM P 900**

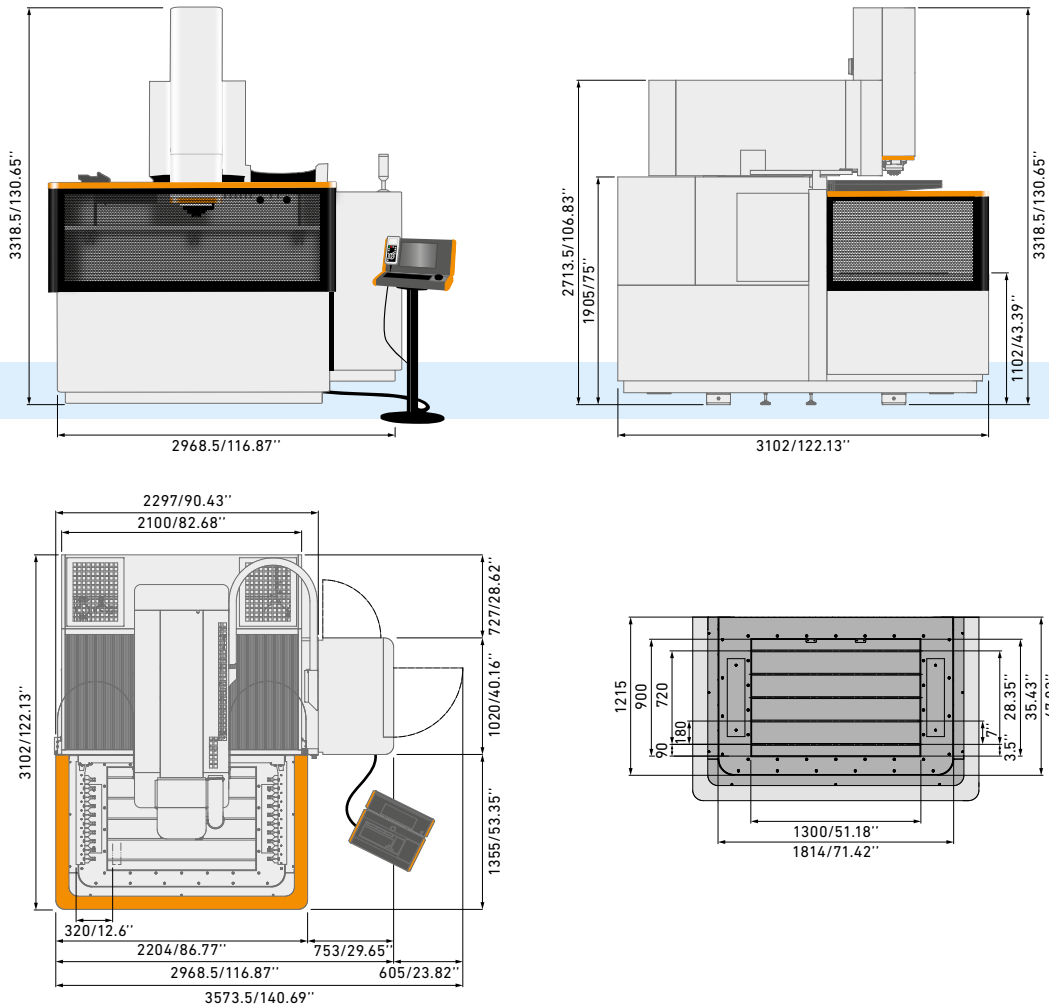

**FORM P 350/600 + Rotary tool changer (RTC)**

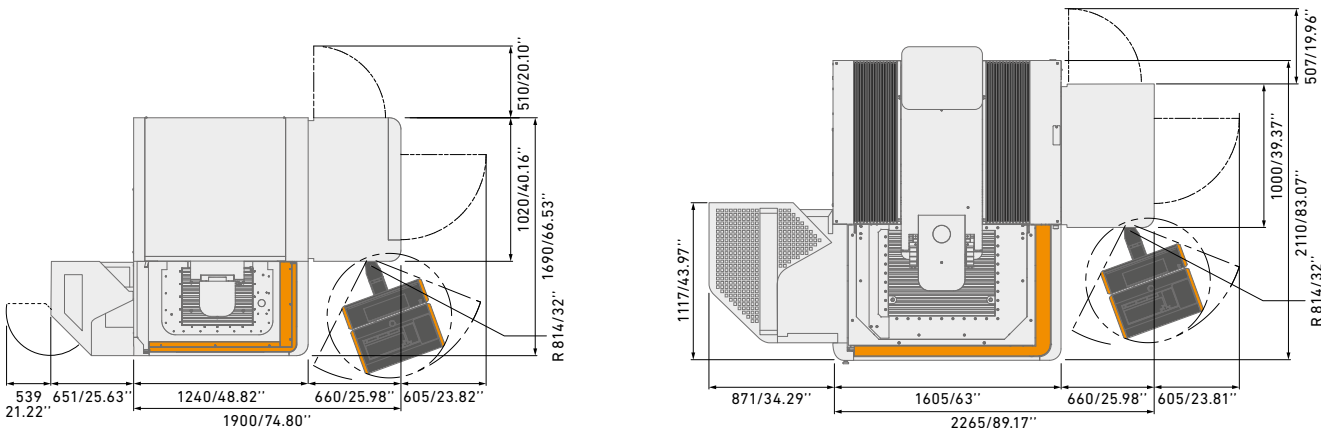

FORM P 350 + RTC

FORM P 600 + RTC

## About GF Machining Solutions

# Multi-technology solutions provider

Our commitment to you and your specific applications is proven by the value-adding intelligence, productivity and quality delivered by our multi-technology solutions. Your success is our chief motivator. That's why we are continuously advancing our legendary technical expertise. Wherever you are, whatever your market segment and whatever the size of your operation, we have the complete solutions and the customer-centric commitment to accelerate your success—today.

### EDM (Electrical Discharge Machining)



#### Wire-cutting EDM

GF Machining Solutions' wire-cutting EDM is fast, precise and increasingly energy efficient. From ultraprecise machining of miniaturized components down to 0.02 mm to powerful solutions for demanding high-speed machining with respect to surface accuracy, our wire EDM solutions position you for success.

#### Die-sinking EDM

GF Machining Solutions is revolutionizing die-sinking EDM with features like iGAP technology to dramatically boost machining speed and reduce electrode wear. All of our die-sinking systems offer fast removal and deliver mirror finishes of Ra 0.1 µm (4 µin).

#### Hole-drilling EDM

GF Machining Solutions' robust hole-drilling EDM solutions enable you to drill holes in electrically conductive materials at a very high speed—and, with a five-axis configuration, at any angle on a workpiece with an inclined surface.

### Tooling and Automation



#### Tooling

Our customers experience complete autonomy while maintaining extreme accuracy, thanks to our highly accurate System 3R reference systems for holding and positioning electrodes and work pieces. All types of machines can easily be linked, which reduces set-up times and enables a seamless transfer of workpieces between different operations.

#### Automation

Together with System 3R, we also provide scalable and cost-effective Automation solutions for simple, single machine cells or complex, multi-process cells, tailored to your needs.

### Milling



#### Milling

Precision tool and mold manufacturers enjoy a competitive edge with our Mikron MILL S solutions' fast and precise machining. The Mikron MILL P machines achieve above-average productivity thanks to their high performance and Automation. Customers seeking fastest return on investment benefit from the affordable efficiency of our MILL E solutions.

#### High Performance Airfoil Machining

Our Liechti turnkey solutions enable the highly dynamic manufacturing of precision airfoils. Thanks to the unique performance and our expertise in airfoil machining, you increase productivity by producing at the lowest cost per part.

#### Spindles

As part of GF Machining Solutions, Step-Tec is engaged in the very first stage of each machining center development project. Compact design combined with excellent thermal and geometric repeatability ensure the perfect integration of this core component into the machine tool.

### Software



#### Digitalization solutions

To drive its digital transformation, GF Machining Solutions acquired symmedia GmbH, a company specialized in software for machine connectivity. Together, we offer a complete range of Industry 4.0 solutions across all industries. The future requires the ability to adapt quickly to continual digital processes. Our intelligent manufacturing offers embedded expertise, optimized production processes, and workshop Automation: solutions for smart and connected machines.

### Advanced manufacturing



#### Laser texturing

Aesthetic and functional texturing is easy and infinitely repeatable with our digitized Laser technology. Even complex 3D geometries, including precision parts, are textured, engraved, microstructured, marked and labeled.

#### Laser micromachining

GF Machining Solutions offers the industry's most complete line of Laser micromachining platforms optimized for small, high-precision features to meet the increasing need for smaller, smarter parts to support today's leading-edge products.

#### Laser Additive Manufacturing (AM)

GF Machining Solutions and 3D Systems, a leading global provider of additive manufacturing solutions and the pioneer of 3D printing, have partnered to introduce new metal 3D printing solutions that enable manufacturers to produce complex metal parts more efficiently.

### Service + Success



#### We take you to new heights

Our Success Packs are designed to maximise your return on investment and empower you in your quest for success across all industrial segments. Our subscription packs feature a comprehensive range of services that guarantee the access and support you need to get the most out of your assets today, while preparing for the challenges of tomorrow. Our trusted experts backed by our latest cutting-edge, intelligent Digital Solutions, provide a full range of services.

#### eCatalog

Keep your equipment operating at peak precision and performance with our wide range of certified consumables and original wear parts. Our online catalog has it all ([ecatalog.gfms.com](http://ecatalog.gfms.com)).



## Our locations

### Switzerland

Headquarters  
Biel/Bienne +++

Losone +++  
Geneva ++  
Langnau ++

### Europe

Schorndorf, Germany ++  
Coventry, United Kingdom ++  
Agrate Brianza (MI), Italy ++  
Barcelona, Spain ++  
Marinha Grande, Portugal +  
Massy, France +  
La Roche Blanche, France +  
Lomm, Netherlands ++  
Altenmarkt, Austria ++  
Warsaw, Poland ++  
Brno, Czech Republic ++  
Budapest, Hungary ++  
Vällingby, Sweden +

### America

USA  
Lincolnshire (IL) ++  
Chicago (IL) ++  
Huntersville (NC) ++  
Irvine (CA) ++  
  
Toronto (Vaughan), Canada ++  
Monterrey, Mexico ++  
São Paulo, Brazil +  
Caxias do Sul, Brazil +

### Asia

China  
Beijing +++  
Changzhou ++  
Shanghai ++  
Chengdu ++  
Dongguan ++  
Hong Kong +  
  
Yokohama, Japan ++  
Taipei, Taiwan +  
Taichung, Taiwan ++  
Seoul, Korea ++  
Singapore, Singapore ++  
Petaling Jaya, Malaysia ++  
Bangalore, India ++  
Pune, India +  
Hanoi, Vietnam ++

+ Plant    ++ Center of Demonstration    +++ Sales company

## At a glance

We enable our customers to run their businesses efficiently and effectively by offering innovative Milling, EDM, Laser, Additive Manufacturing, Spindle, Tooling and Automation solutions. A comprehensive package of services completes our proposition.

[www.gfms.com](http://www.gfms.com)



© GF Machining Solutions Management SA, 2024  
The technical data and illustrations are not binding.  
They are not warranted characteristics and are  
subject to change.